

Low Profile Tri-band SMD Ceramic Chip Antenna for Wi-Fi Applications

Product Datasheet **AC10300-01**

July, 2023

Rev. 1.0

Revision History

Date	Rev.	Summary of Changes
17 July 2023	1.0	First version of preliminary product datasheet

Table of Contents

1	DESCRIPTION AND SPECIFICATIONS.....	4
1.1	Scope and purpose.....	4
1.2	Features	4
1.3	Antenna specifications.....	5
1.4	Radiation pattern.....	7
1.5	VSWR and Antenna Efficiency	8
2	PRODUCT HANDLING & INTEGRATION	9
2.1	Assembly Recommendation	9
2.2	Antenna Footprint	10
2.3	Evaluation Kit	11
2.4	Matching Network Topology	12
2.5	Assembly Recommendation: Reflow Profile	13
3	PRODUCT MARKING & ORDERING INFORMATION.....	14
3.1	Packaging	14
3.2	Product Marking.....	15
3.3	Ordering Information.....	16

1 Description and Specifications

1.1 Scope and purpose

The AC10300-01 is an ultra-small high efficiency SMD ceramic chip antenna supporting WLAN/Wi-Fi 6E 2400-2500, 4900-7125 MHz; the antenna is ideal for MIMO applications using multiple antennas placed on the same PCB:

- Access points
- M2M industrial
- Smart Grid
- Smart meters
- Connected health (patient monitoring)
- Set Top Box

1.2 Features

- Ultra-small high efficiency antenna
- Low profile (< 0.8mm) SMD component for ease of integration
- Ideal for MIMO systems 2x2, 4x4, 8x8
- Simple integration, plug and operate the device without designing onboard antenna
- Surface mount device suitable for automated assembly (SMT process)
- Supplied on tape & reel
- Small form factor of 1.6 x 0.8 x 0.8 (mm)
- RoHS and REACH-compliant
- For WLAN Applications 2.4 - 2.5 GHz; 4.9 - 5.85 GHz; 5.90 - 7.125 GHz

1.3 Antenna specifications

Table 1: AC10300-01 RF specifications

Parameters	Band		
	2400 – 2485MHz	4900 – 5850MHz	5900 – 7125MHz
Frequency (MHz)	2400 – 2485MHz	4900 – 5850MHz	5900 – 7125MHz
Typical efficiency	45% - 55%	40% - 62%	40% - 62%
Peak Gain	0.5dBi	2.26dBi	2.52dBi
VSWR (max)	<3.0:1	< 5.0:1	< 4.5:1
GND plane size	30 x 50 mm		
Input impedance	50Ω		
Polarization	Linear		

Notes:

- The characterization is performed with the antennas mounted on the evaluation board AC91300-050 with size W x L = 30 x 50mm.
- The evaluation board is tested in free space.

Table 2: AC10300-01 physical specifications

Parameter	AC10300-01
Size (L x W x H)	1.6 x 0.8 x 0.8 (mm)
Required clearance area	8.9 x 5.8 (mm)
Weight	< 0.2 g
Soldering Type	SMT through reflow

Notes:

- For all dimensions, the ISO 2768-mK standard is followed. For the outer dimensions this means a tolerance of ±0.1 mm is applicable

Table 3: AC10300-01 environmental specifications

Parameter	AC10300-01
Operational temperature	-40 °C to +125 °C
Storage temperature	-10 °C to +40 °C
Relative humidity	≤75%
RoHS and REACH	Yes

The visual representation and the dimensions of the AC10300-01 antenna are shown in Figure 1.

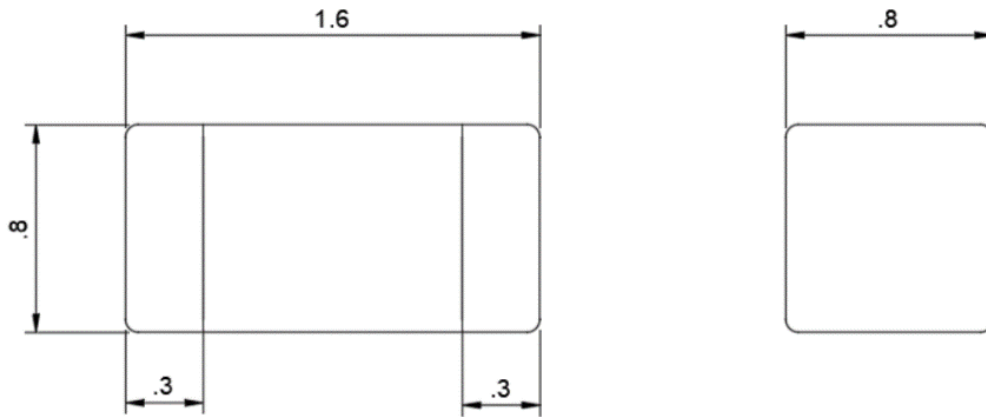
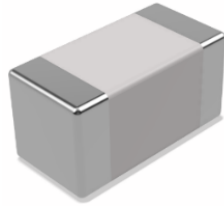

Figure 1: AC10300-01 visual representation and dimensions (in mm)

1.4 Radiation pattern

The typical radiation patterns of the AC10300-01 antenna, measured when operating on a 30 x 50 mm host PCB, are depicted in Table 4. The axes orientation during the measurements is demonstrated in Figure 2.

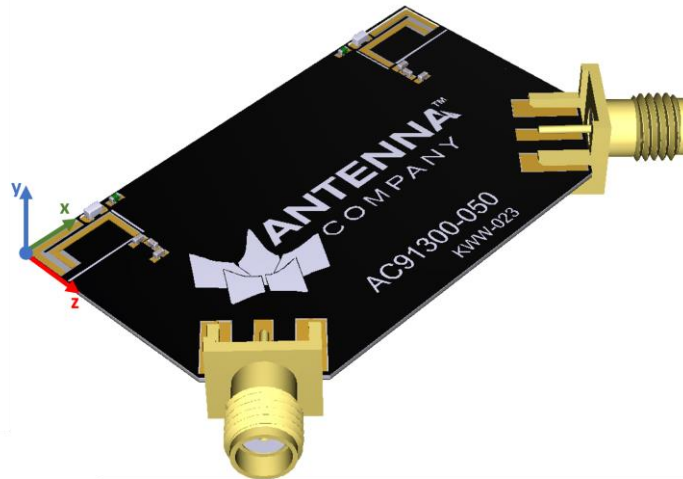
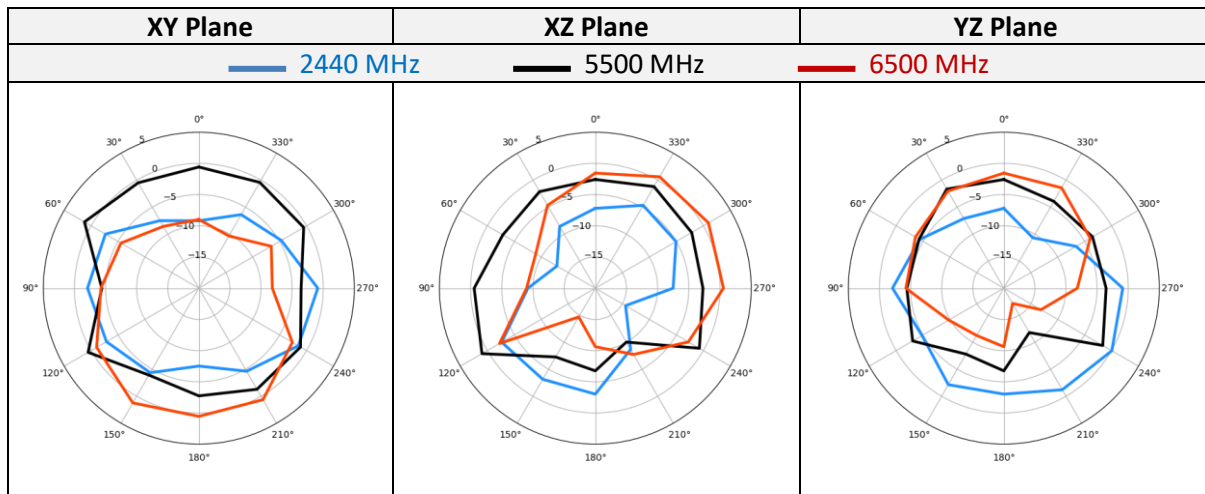

Figure 2: Illustration of radiation pattern evaluation planes

Table 4: Radiation patterns of AC10300-01



1.5 VSWR and Antenna Efficiency

The AC10300-01 has been characterized on the AC91300-050 evaluation board.

The measured VSWR and efficiency as functions of frequency are depicted in Figures 3 and 4, respectively.

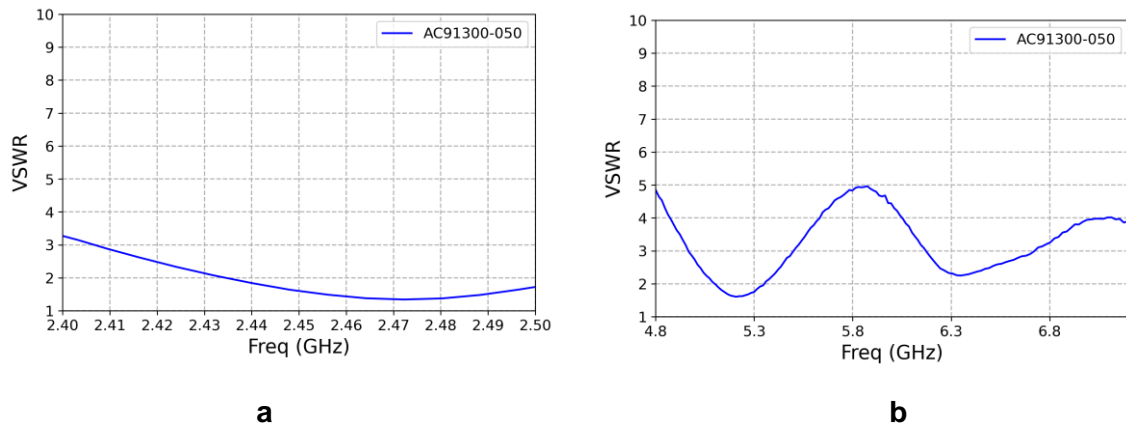

Figure 3: VSWR of the AC10300-01. 2G VSWR (a) and 5G/6G VSWR (b)

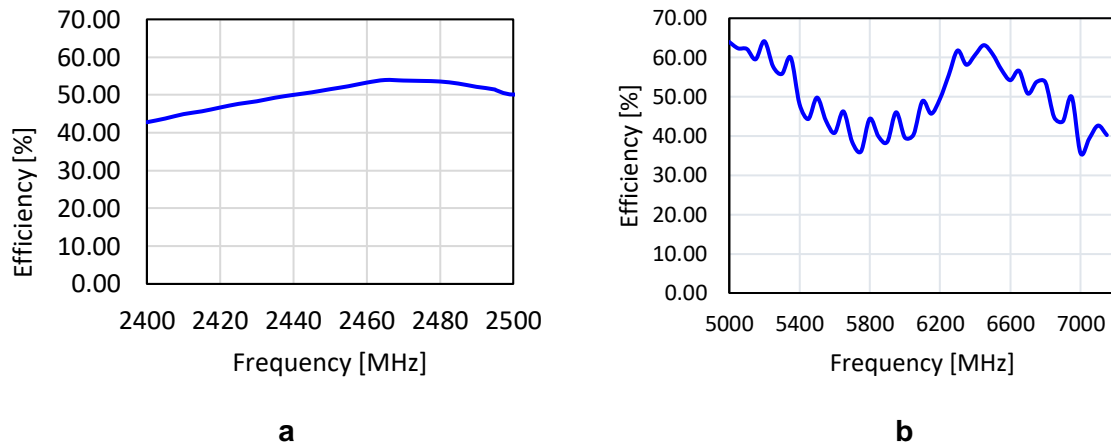

Figure 4: Efficiency of the AC10300-01. 2G efficiency (a) and 5G/6G efficiency (b)

2 Product Handling & Integration

2.1 Assembly Recommendation

Figure 5 and Figure 6 show the recommended location of the AC10300-01 antenna on the host PCB. The antenna is designed to function placed at the PCB corner. A ground-free clearance area (5.8 x 8.9) mm highlighted by the green rectangle (see Figure 6) is required through all PCB layers. Any components, such as batteries or displays, must avoid this area.

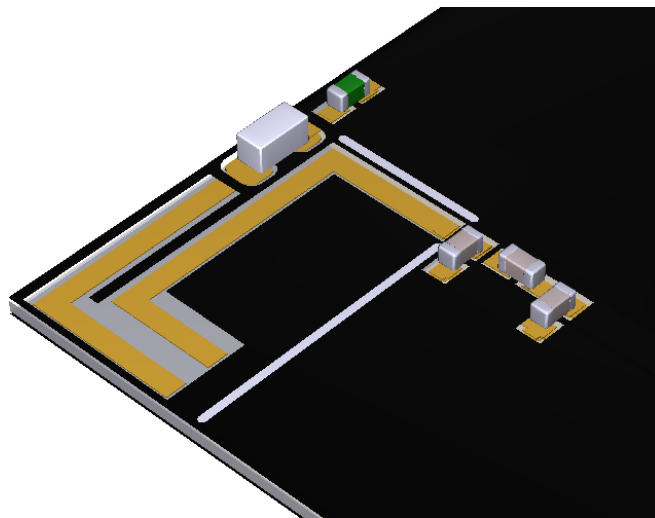

Figure 5: Isometric view of the AC10300-01 placement on the host PCB

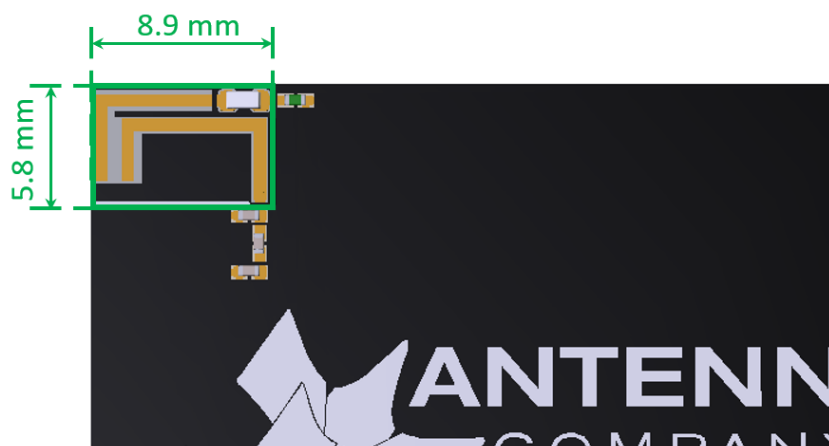

Figure 6: AC10300-01 integration on the top surface of the host PCB

2.2 Antenna Footprint

The required PCB footprint is shown in Figure 7. Pad 1 is location for feed, while pads 2 and 3 are antenna pads. Trace width for all traces is 0.6 mm.

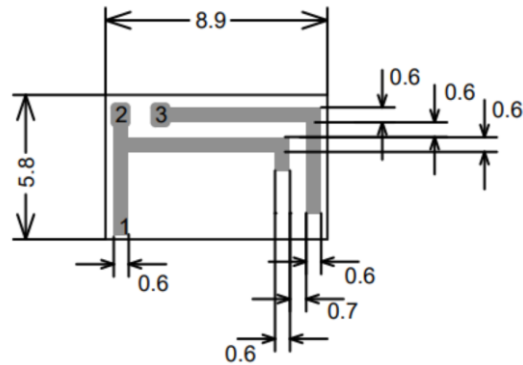

Figure 7: Footprint of the AC10300-01 on the top PCB layer. All dimensions are given in mm

Additional notes

- Any inner PCB layer should be free from ground in the antenna section, delimited by the 5.8 x 8.9 mm clearance area.
- The top and bottom layers of the PCB should be flooded with GND to optimize the antenna performance.
- For all dimension tolerances, standard PCB manufacturing guidelines should be followed.

2.3 Evaluation Kit

The evaluation kit depicted in Figures 8 and 9 includes SMA female connectors and can be ordered for evaluation purposes. As shown on the evaluation board, it is recommended to mount the ceramic chip antenna in the corner of the PCBA.

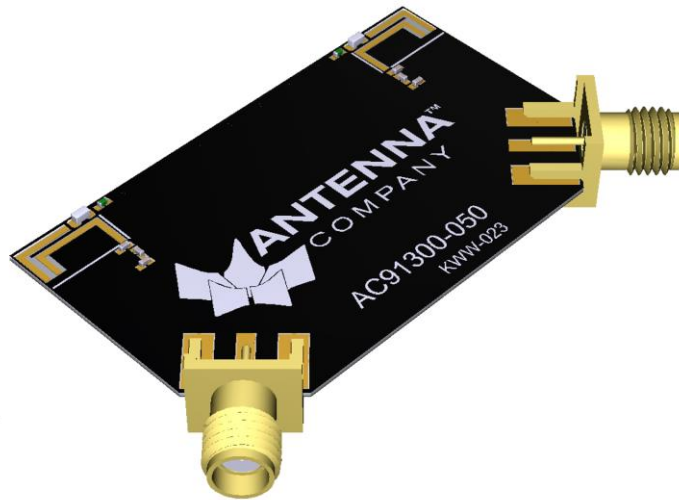

Figure 8: Isometric view of the evaluation kit

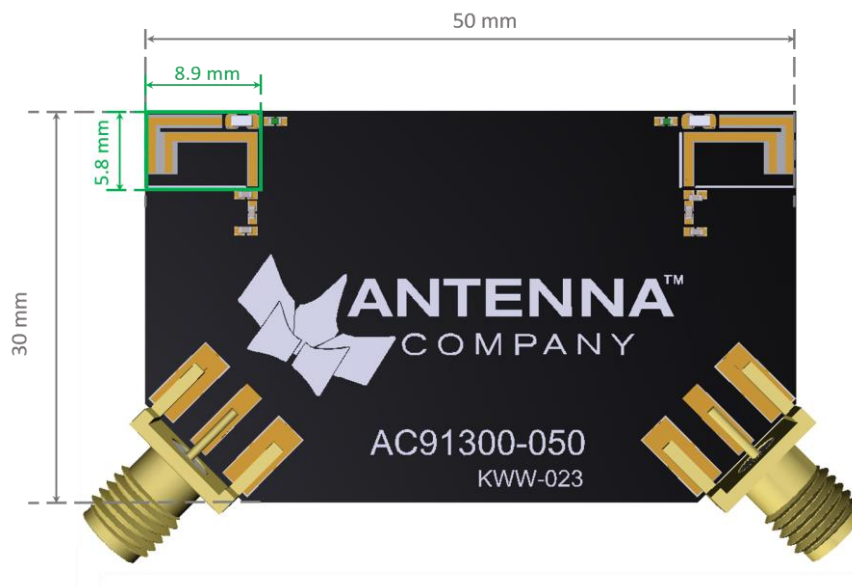

Figure 9: Top view of the evaluation board

2.4 Matching Network Topology

The matching network topologies depicted in Figure 10 are required on the main PCB, as close as possible to the AC10300-01 antennas. The characteristic impedance of all transmission lines should be designed as 50Ω. The AC91300-050 shows the placement for 2x2 MIMO with two AC10300-01 antennas on the board. The length of the transmission lines connecting the antenna to the matching circuit and the radio module should be kept as short as possible. Any other part of the RF circuit connected to the antenna, such as power amplifiers, should also be designed with a 50Ω impedance.

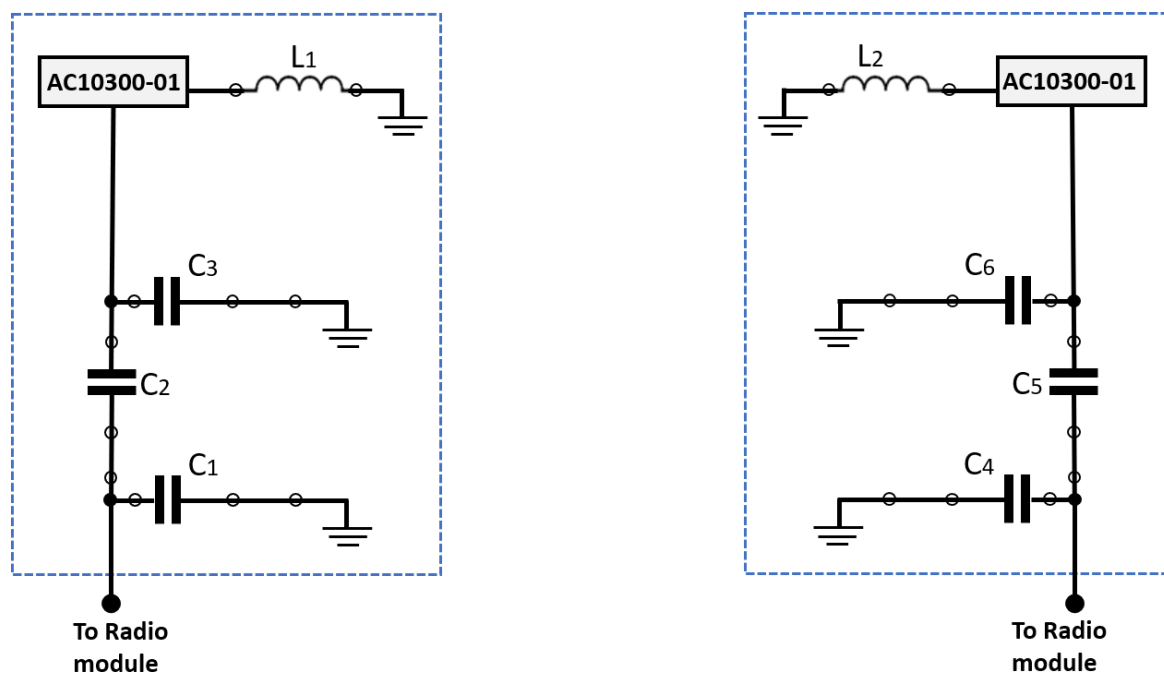

Figure 10: Required matching network topology for AC10300-01

The component values and recommended types are listed in Table 5. Different values might be required depending on the host PCBA and the end-device environment. If you need assistance, please contact sales@antennacompany.com for antenna matching network support.

Table 5: Matching network component values

AC10300-01		
Component	Value	Type
Capacitors (C ₁ , C ₃ , C ₄ , C ₆)	0.2 pF	GJM1555C1HR20BB01
Capacitors (C ₂ , C ₅)	10 pF	GJM1555C1H100JB01
Inductors (L ₁ , L ₂)	4.3 nH	LQG15HN4N3B02

2.5 Assembly Recommendation: Reflow Profile

The recommended reflow profile is presented in Figure 11 and Table 6.

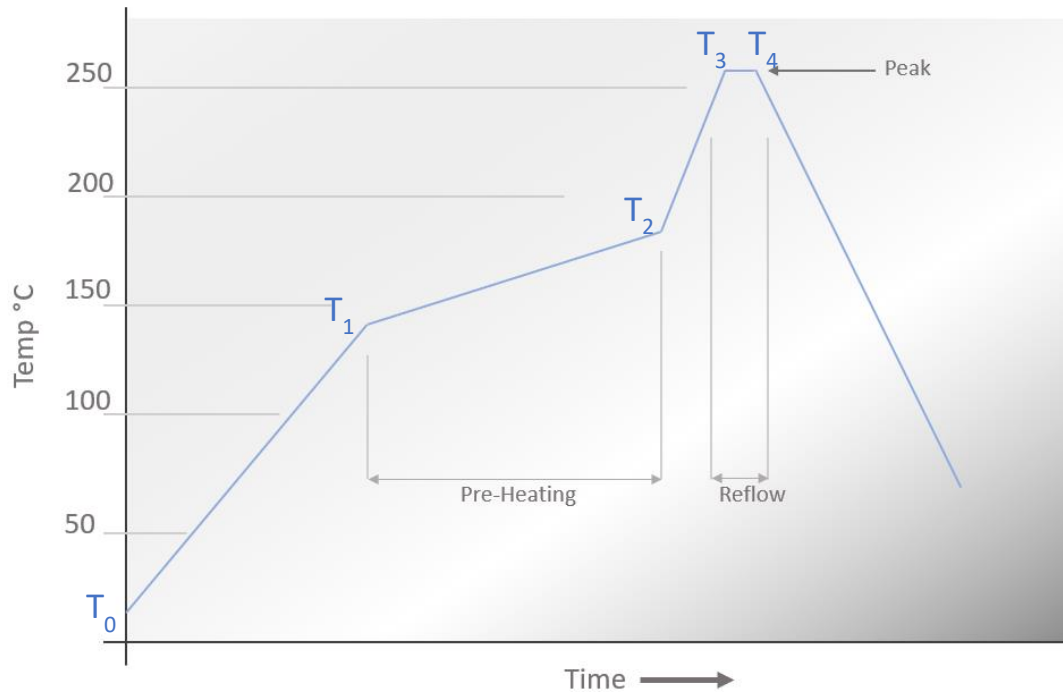

Figure 11: Suggested Reflow profile

Table 6 - Reflow Temperature Table

		Temp Range	Time
$T_0 - T_1$	Heating Zone	0 to 130°C	Controlled 1°C~3°C/sec
$T_1 - T_2$	Pre-Heating	130°C to 180°C	50s to 190s
$T_3 - T_4$	Peak Temperature	260°C	15s to 45s
	Reflow	220°C to 260°C	50s to 160s
$T_4 - \text{End}$	Cooling Zone	Cool down	Controlled ~4°C/sec

3 Product Marking & Ordering Information

3.1 Packaging

The AC10300-01 main antenna will be delivered in tape and reel. The packaging details are presented in Table 7 and Figures 12, 13. The number of units per reel is 4000pcs.

Table 7. AC10300-01 packaging details.

	A0	B0	W	T	T1	P0	P1	P2	D0	E1	E2	F
TOLERANCES	typ.	typ.	+0.3/-0.1	typ.	max	±0.1		+0.05	+0.1/-0.0	±0.1	min.	±0.05
Size (mm)	1.05	1.85	8.00	0.95	0.10	4.00	4.00	2.00	1.50	1.75	6.25	3.50

	A	B	C	D	N	W1	W2	W3	W3	Type	material	VPE
TOLERANCES	±2.0	min.	min.	min.	min.	+1.5	max.	min.	max.			pcs
Size (mm)	178	1.5	12.8	20.2	50	8.4	14.4	7.9	10.9	Paper	polystyrene	4000

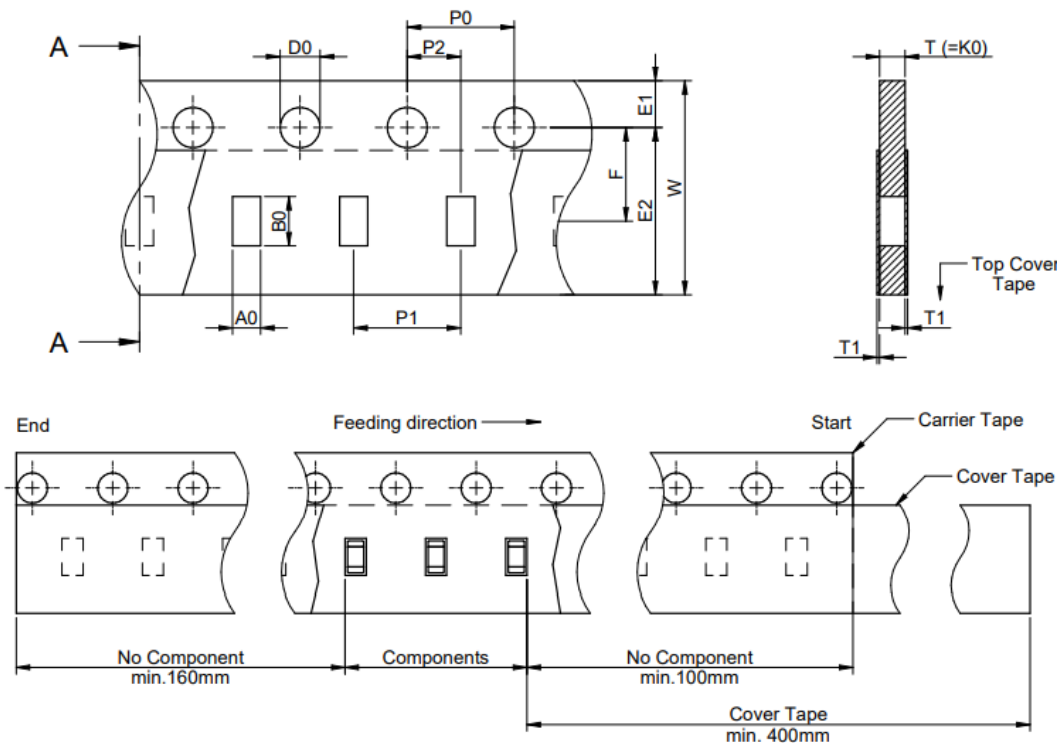

Figure 12: Tape packaging details of AC10300-01

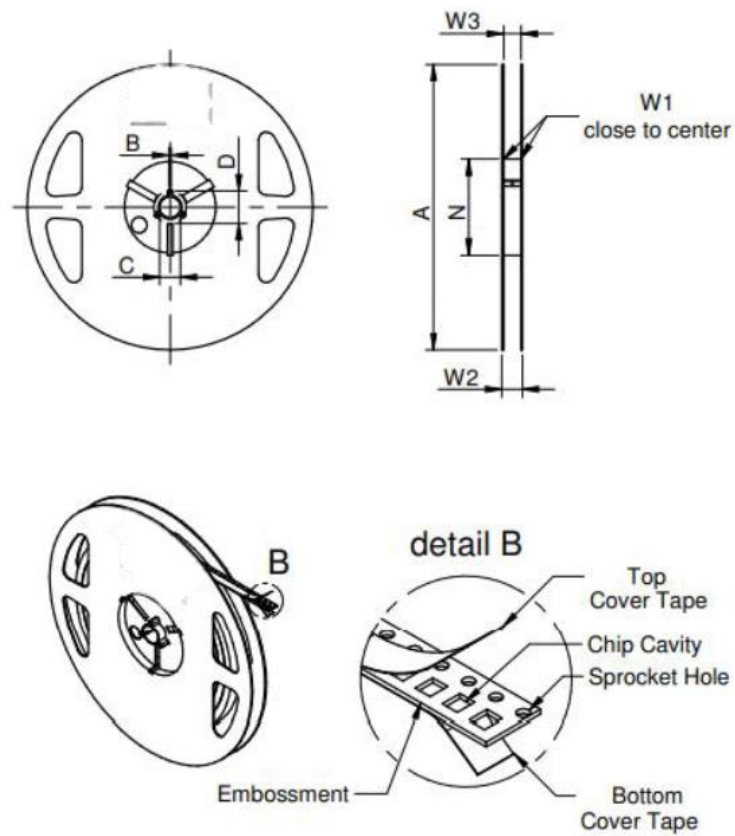

Figure 13: Reel packaging details of AC10300-01

3.2 Product Marking

There will be no markings on the ceramic chip antenna.

3.3 Ordering Information

Orders should be placed at orders@antennacompany.com.

For purchase orders please state: part number, description, quantity, and price

Table 8: AC10300-01, ordering information

Part number	Description	Minimum Order Quantity [pcs]	Order multiple [pcs]
AC10300-01	Wi-Fi Tri-band Ceramic Antenna	4000	4000

For sample quantities, please contact sales@antennacompany.com.

The information furnished by Antenna Company and its agents is believed to be accurate and reliable. Responsibility for the use and application of Antenna Company materials rests with the end user since Antenna Company and its agents cannot be aware of all potential uses. Antenna Company makes no warranties as to the fitness, merchantability, or suitability of Antenna Company materials or products for any specific or general uses. Antenna Company shall not be liable for incidental or consequential damages of any kind. All Antenna Company products are sold pursuant to the Antenna Company terms and conditions of sale in effect from time to time, a copy of which will be furnished upon request. All Antenna Company's products are sold pursuant to the Antenna Company's domestic terms and conditions of sale in effect from time to time, a copy of which will be furnished upon request.

Antenna Company is a registered trademark of The Antenna Company International N.V. Other product and brand names used in this document may be trademarks or registered trademarks of their respective owners.

© 2023 Antenna Company. All rights reserved.