

AMC-ANT-2JW0502-C442B

2.4/5.0GHz ISM hinged connector mount antenna

Features

- 2.4/5.0GHz ISM
 - 2410 – 2490MHz
 - 4920 – 5925MHz
- Ground plane independent
- High gain
- Hinged connector mount
- Dimensions: 173 x \varnothing 10mm



1. Antenna and electrical specifications

Parameters	2.4GHz ISM antenna	
Standards	Wi-Fi, Bluetooth, ZigBee, ISM	
Band (MHz)	2.4GHz	5.0GHz
Frequency (MHz)	2410 - 2490	4920 -5925
Return loss (dB)	~-12.7	~-15.0
VSWR	~1.6:1	~1.6:1
Efficiency (%)	~62	~68
Peak gain (dBi)	~3.5	~4.2
Average gain (dB)	~-2.0	~-1.6
Impedance (Ohms)	50	
Polarisation	Linear	
Radiation pattern	Omni-Directional	
Max. input power (W)	25	
Connector type	RP-SMA male standard	

Measurement Conditions:

- Free space
- Measured in certified CTIA 3D anechoic chamber



2. Mechanical and environmental specifications

Mounting type	Connector mount
Dimensions (mm)	173 x Ø 10
Radome	ABS UV stable
Radome colour	Black
Operating temperature (°C)	-40 to +85
Storage temperature (°C)	-40 to +85
Substance compliance	RoHS

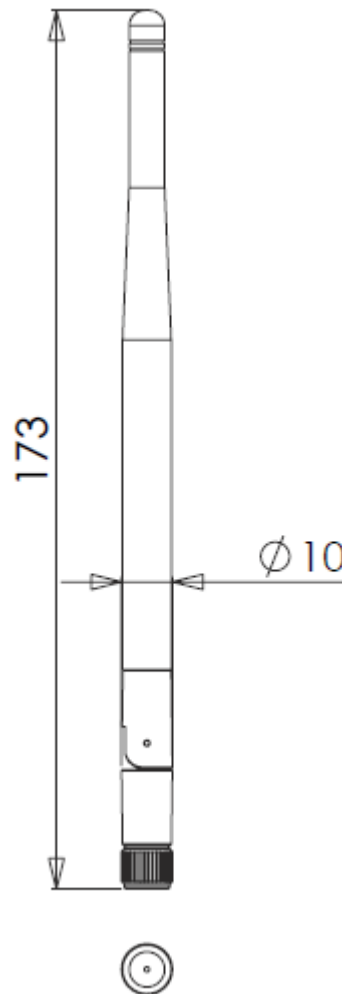

3. Antenna parameters

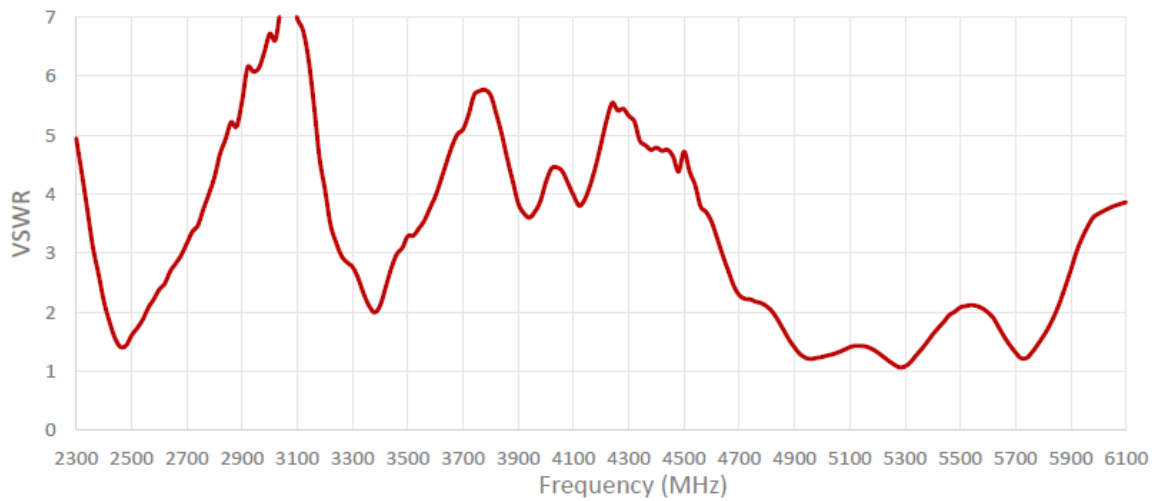
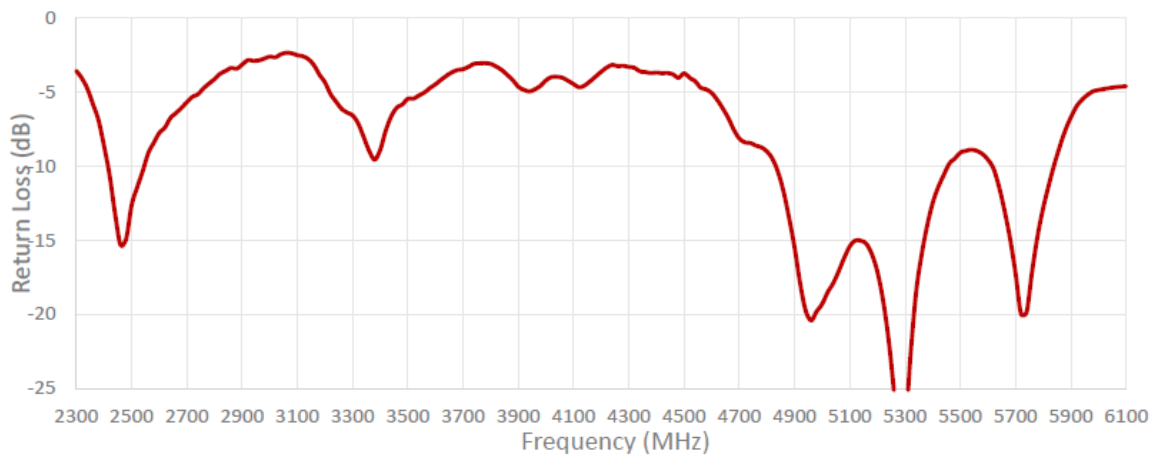

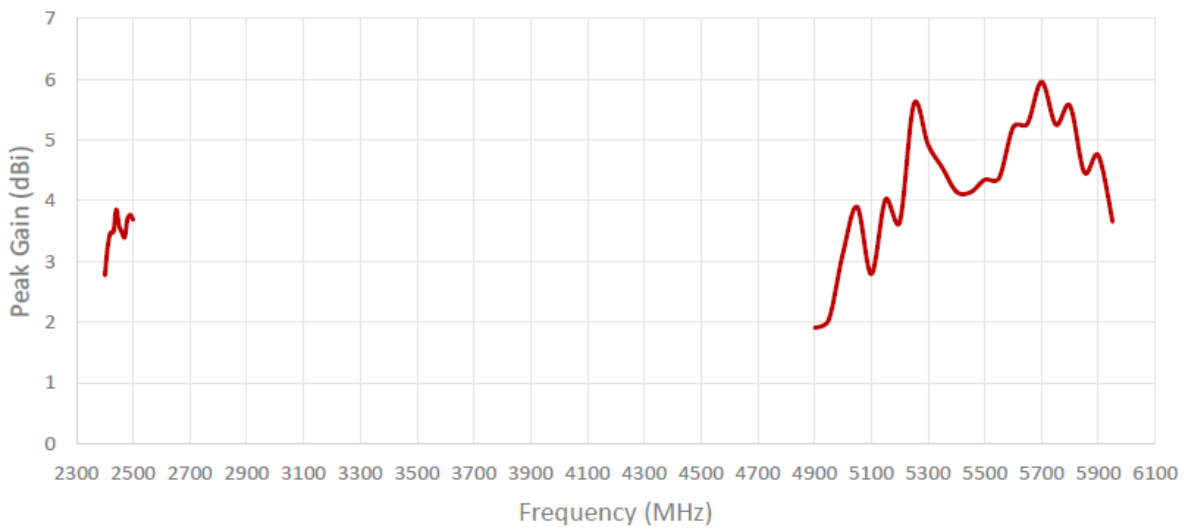
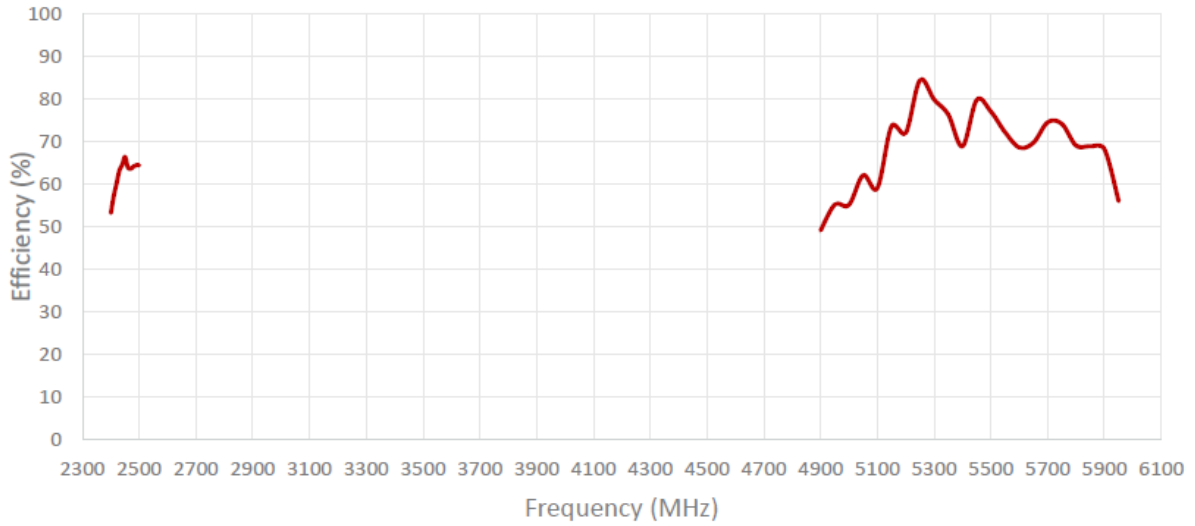

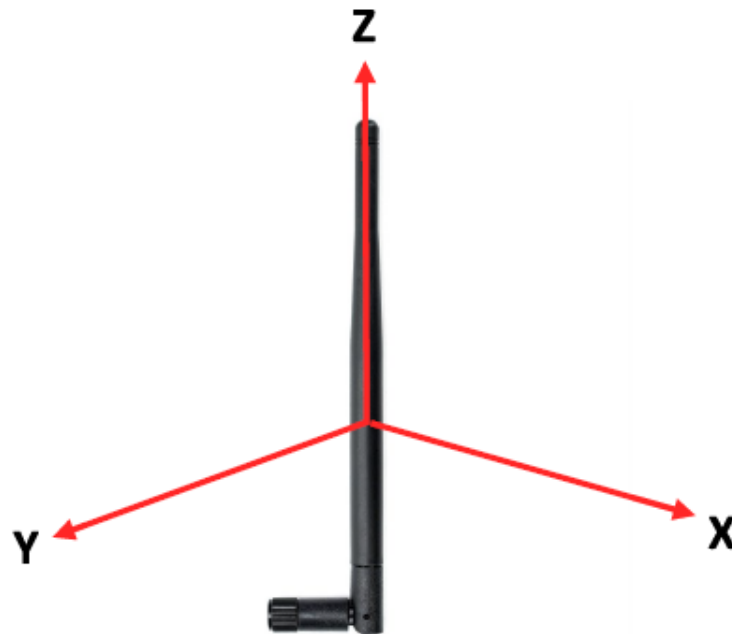
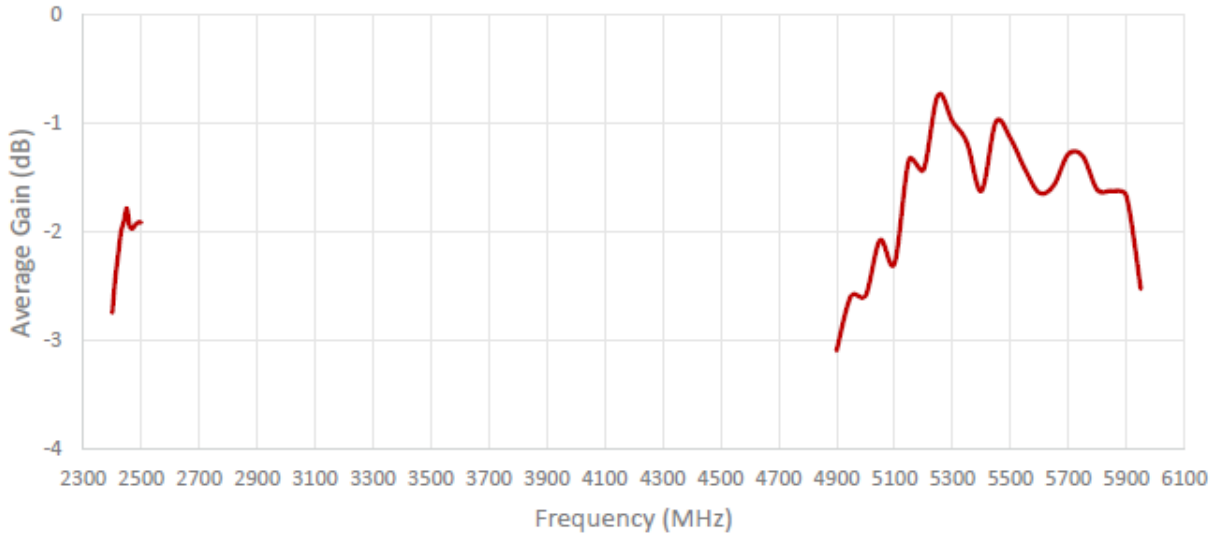

Radiation pattern reference



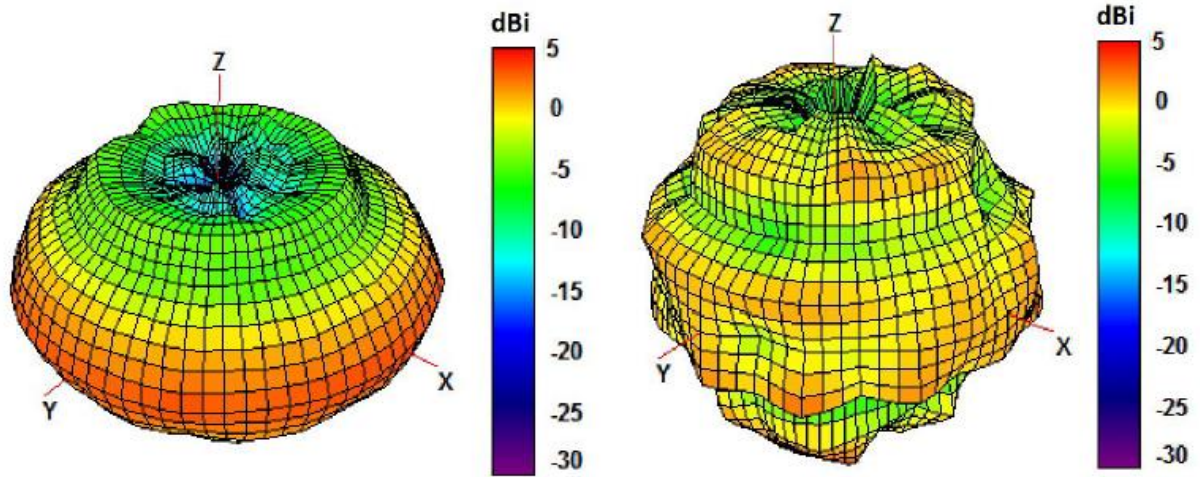

2450 and 5500 MHz Radiation pattern

